

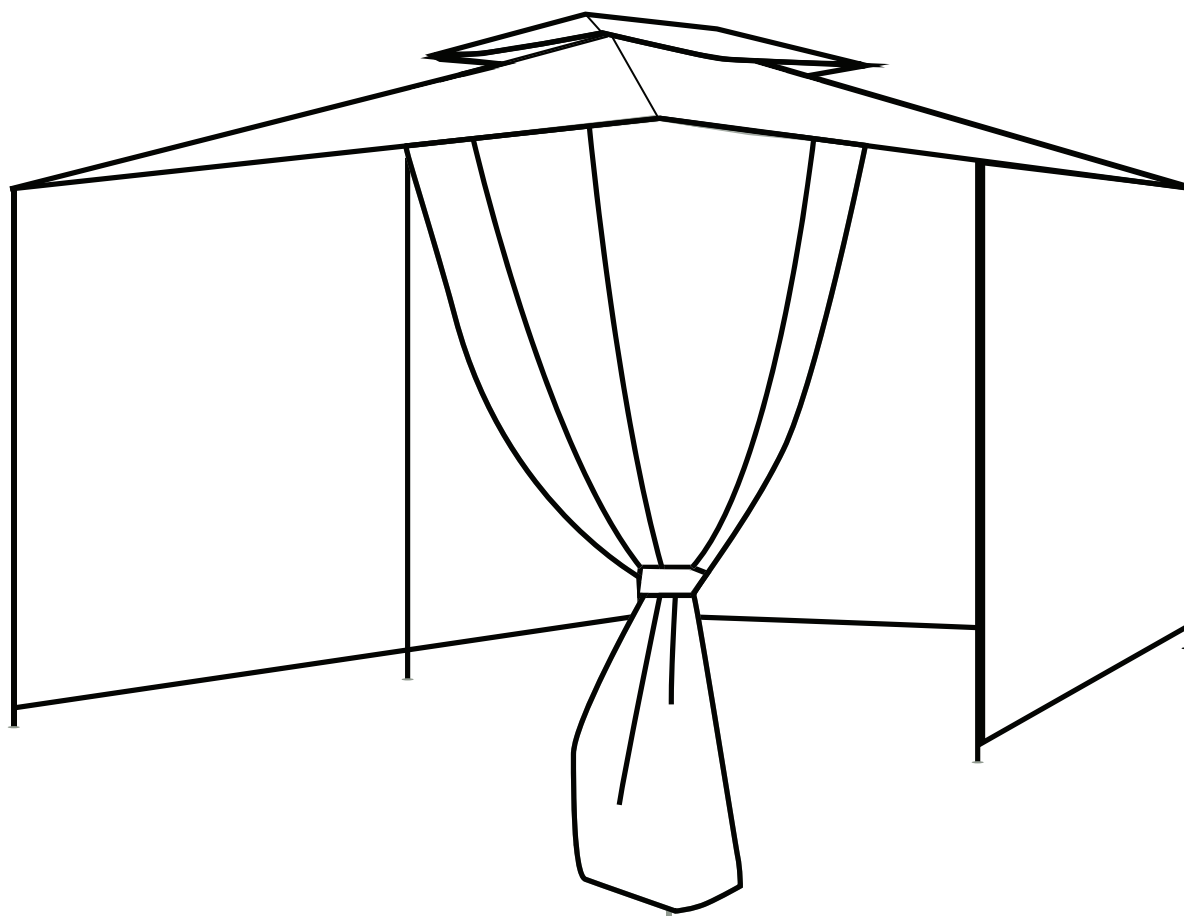

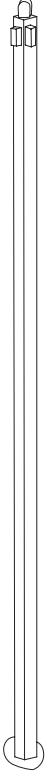

# Instrukcja montażu dla Pawilonu Comfort

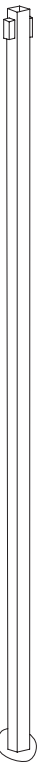
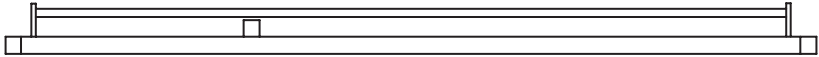
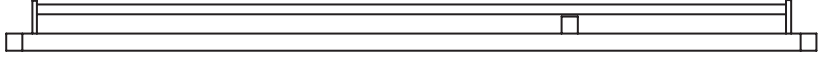
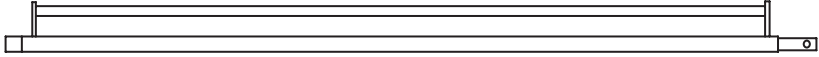
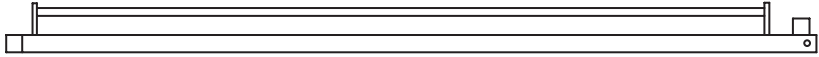

# 1 ZAWARTOŚĆ OPAKOWANIA

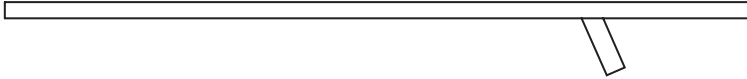
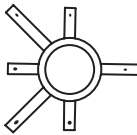
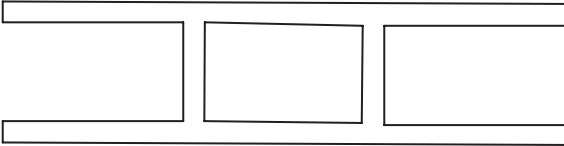
<p>4 x</p>  <p><b>1</b></p>	<p>2 x</p>  <p><b>2</b></p>	<p>2 x</p>  <p><b>3</b></p>	
		<p>2 x</p>  <p><b>4</b></p>	
		<p>2 x</p>  <p><b>5</b></p>	
		<p>2 x</p>  <p><b>6</b></p>	
<p>4 x</p>  <p><b>7</b></p>			
<p>6 x</p>  <p><b>8</b></p>	<p>2 x</p>  <p><b>11</b></p>		
<p>1 x</p>  <p><b>10</b></p>	<p>18 x</p>  <p><b>12</b></p>		
<p>1 x</p>  <p><b>13</b></p>	<p>1 x</p>  <p><b>14</b></p>	<p>6 x</p>  <p><b>15</b></p>	<p>6 x</p>  <p><b>16</b></p>

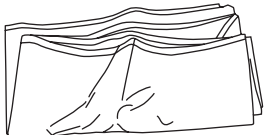
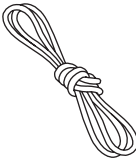
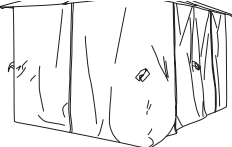

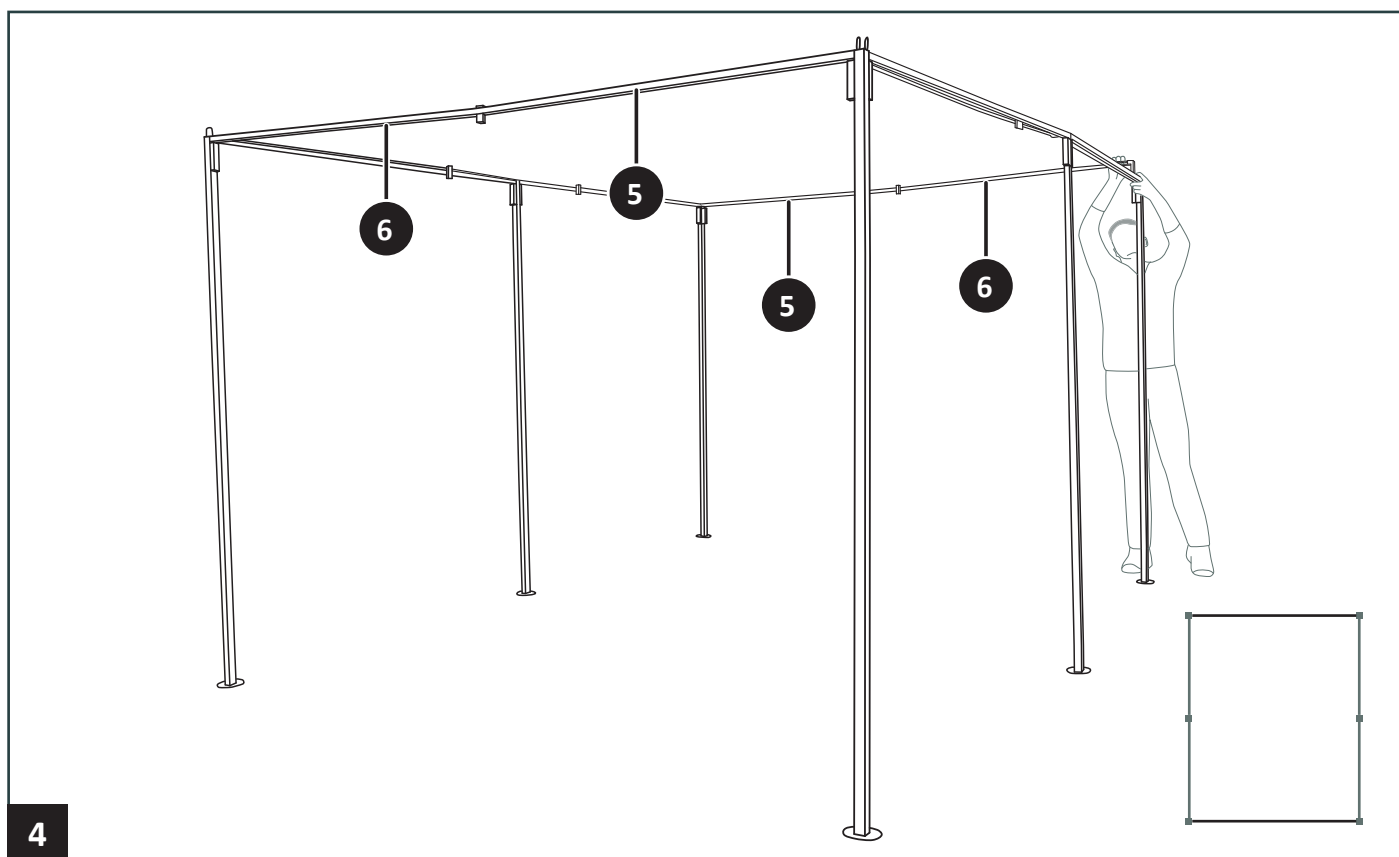
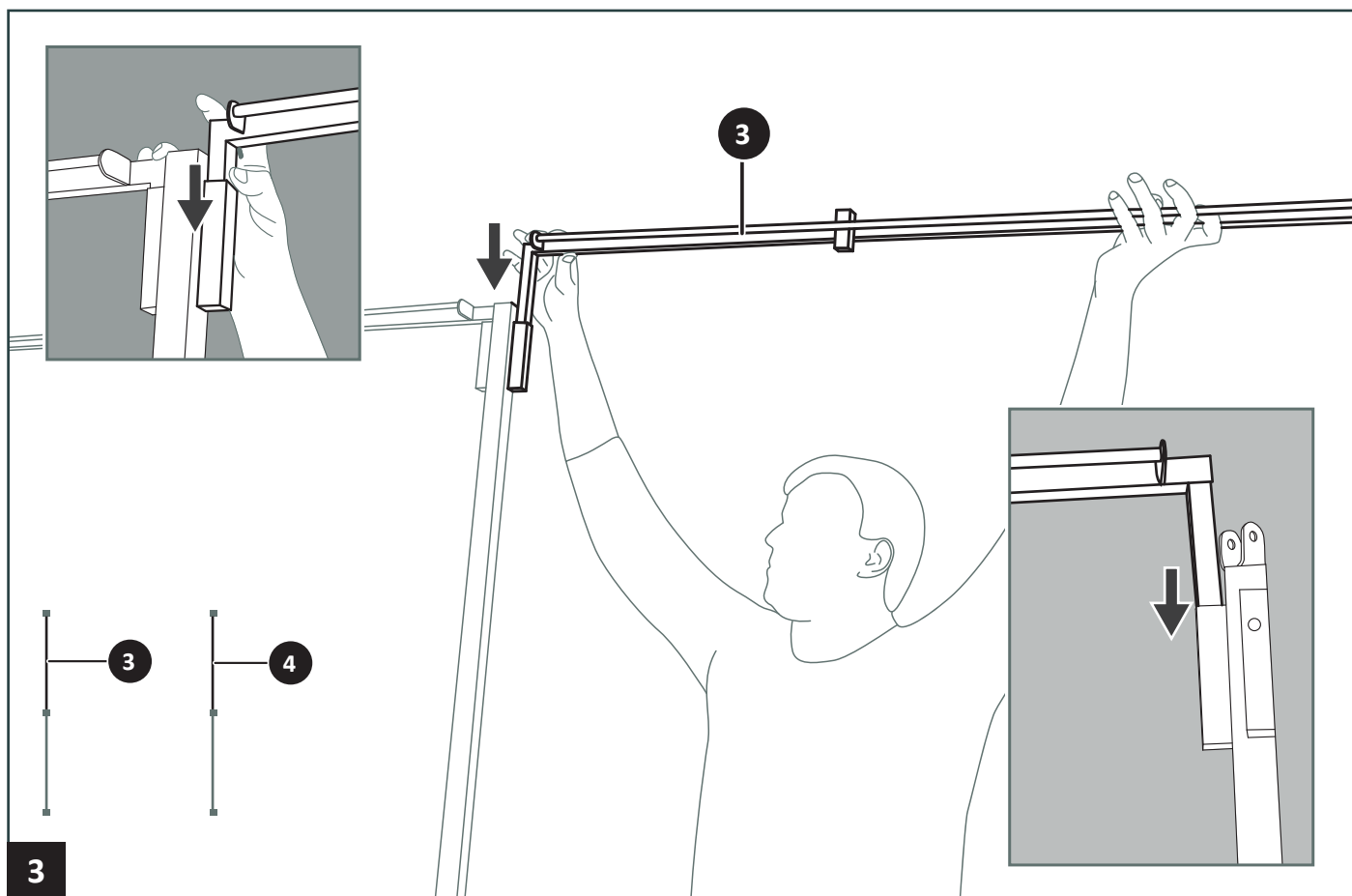

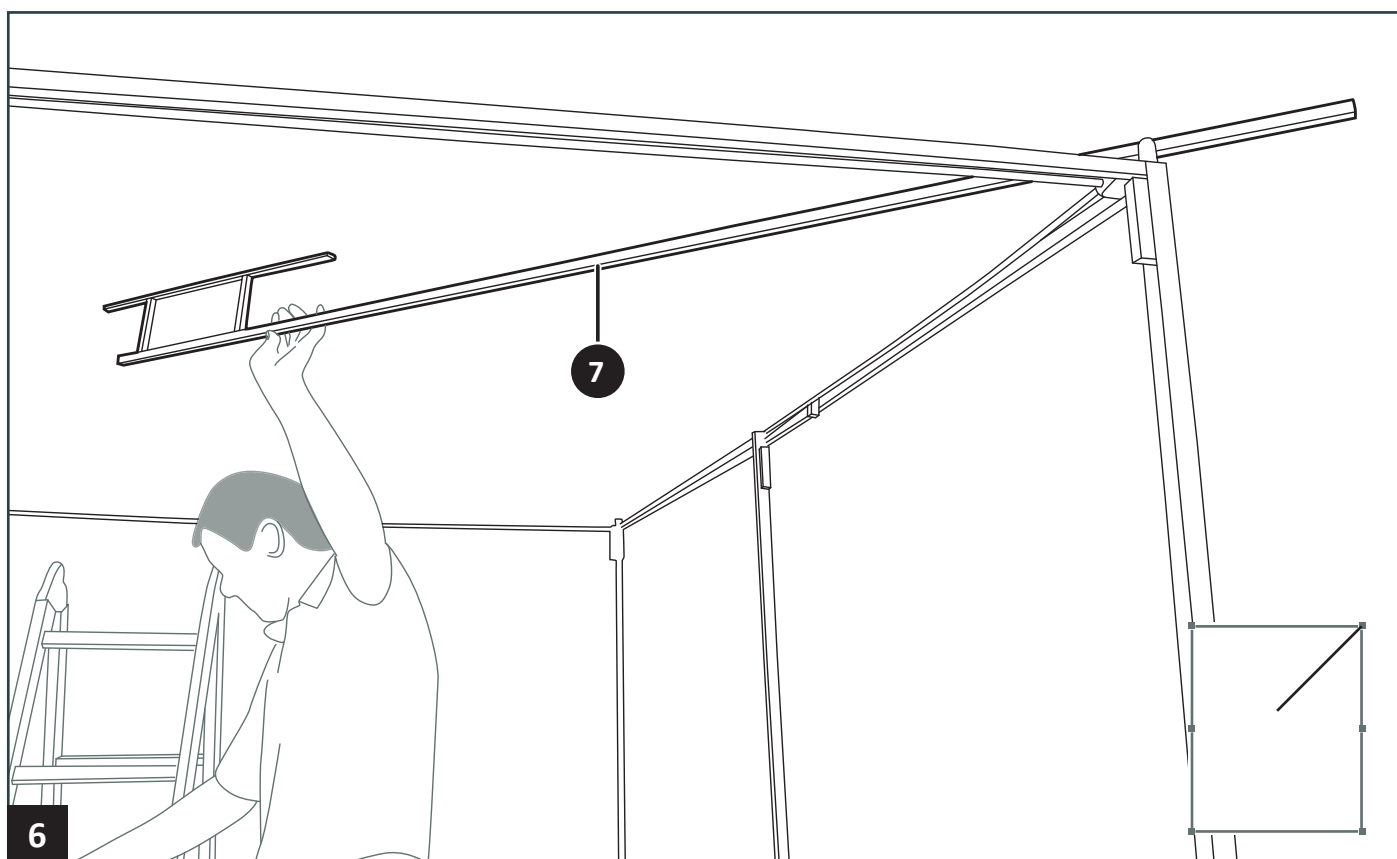
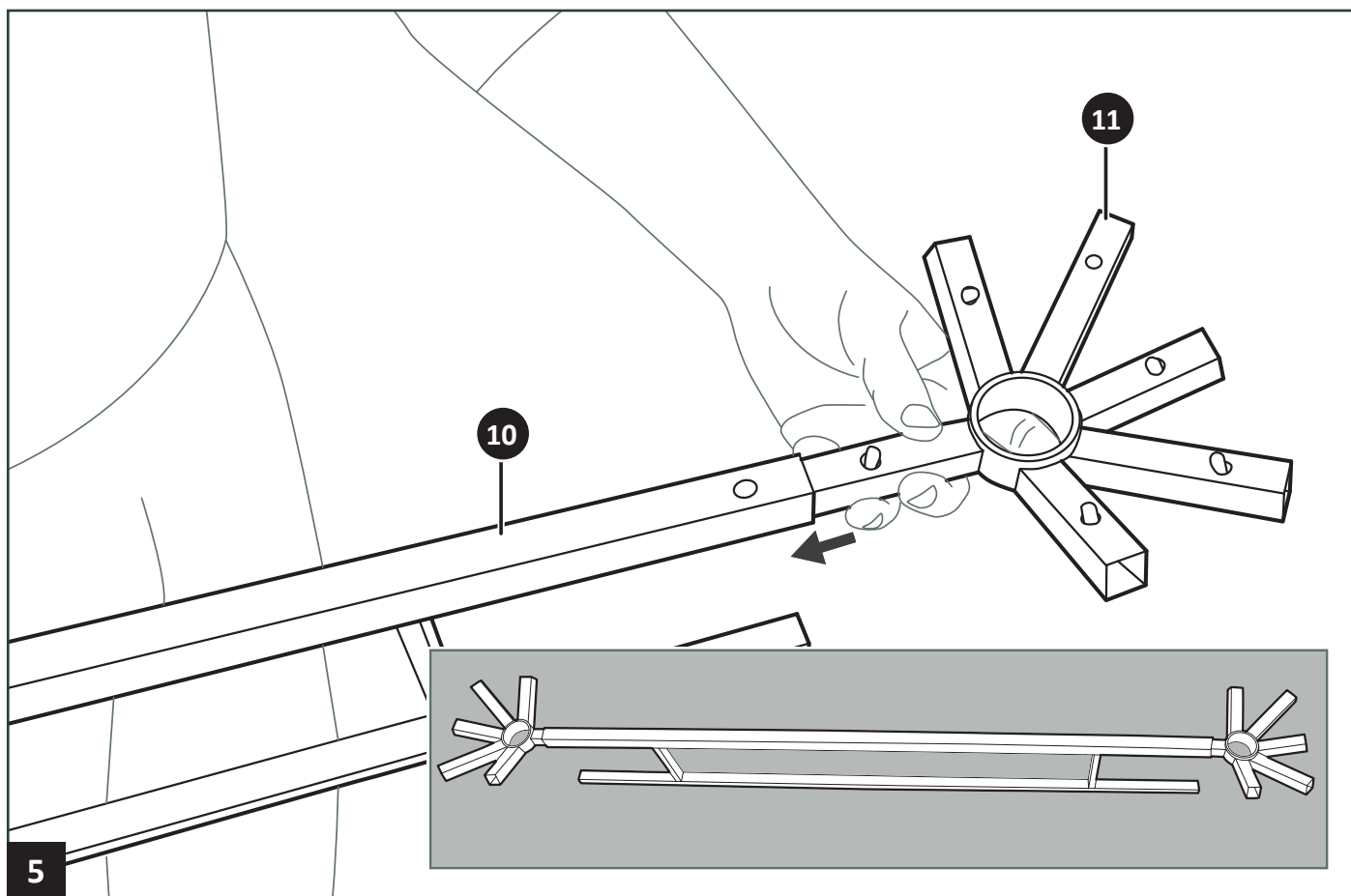

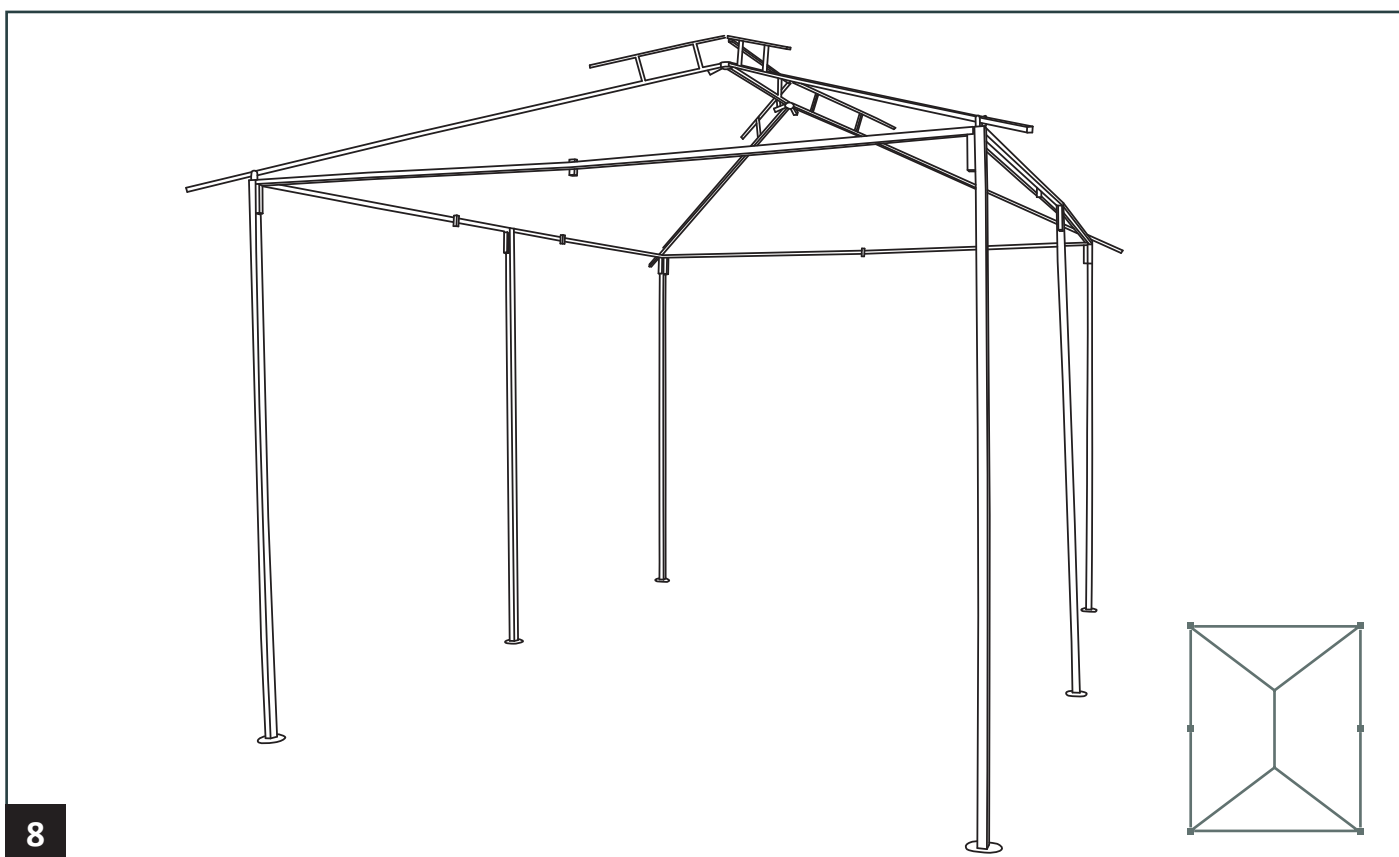
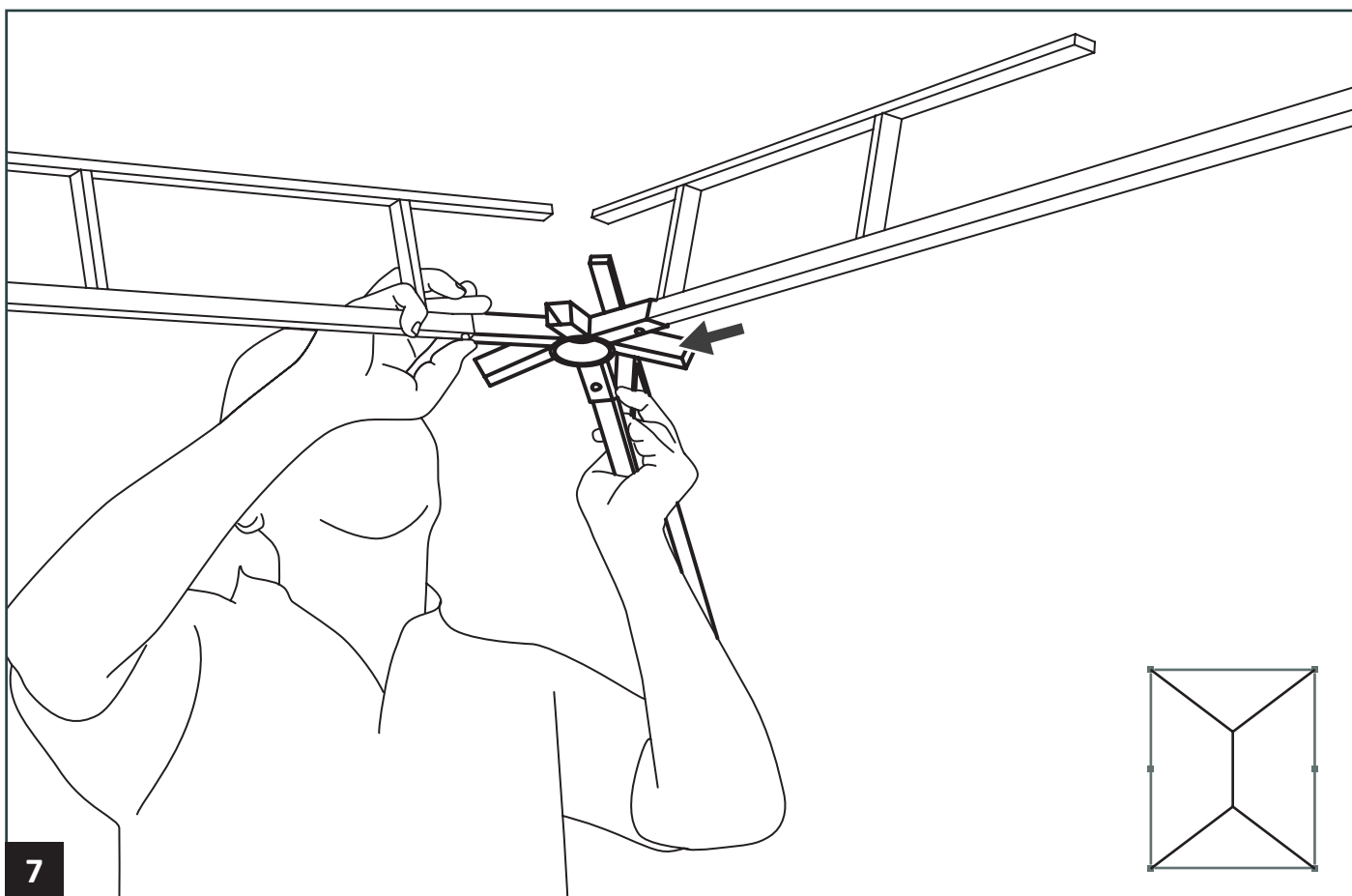

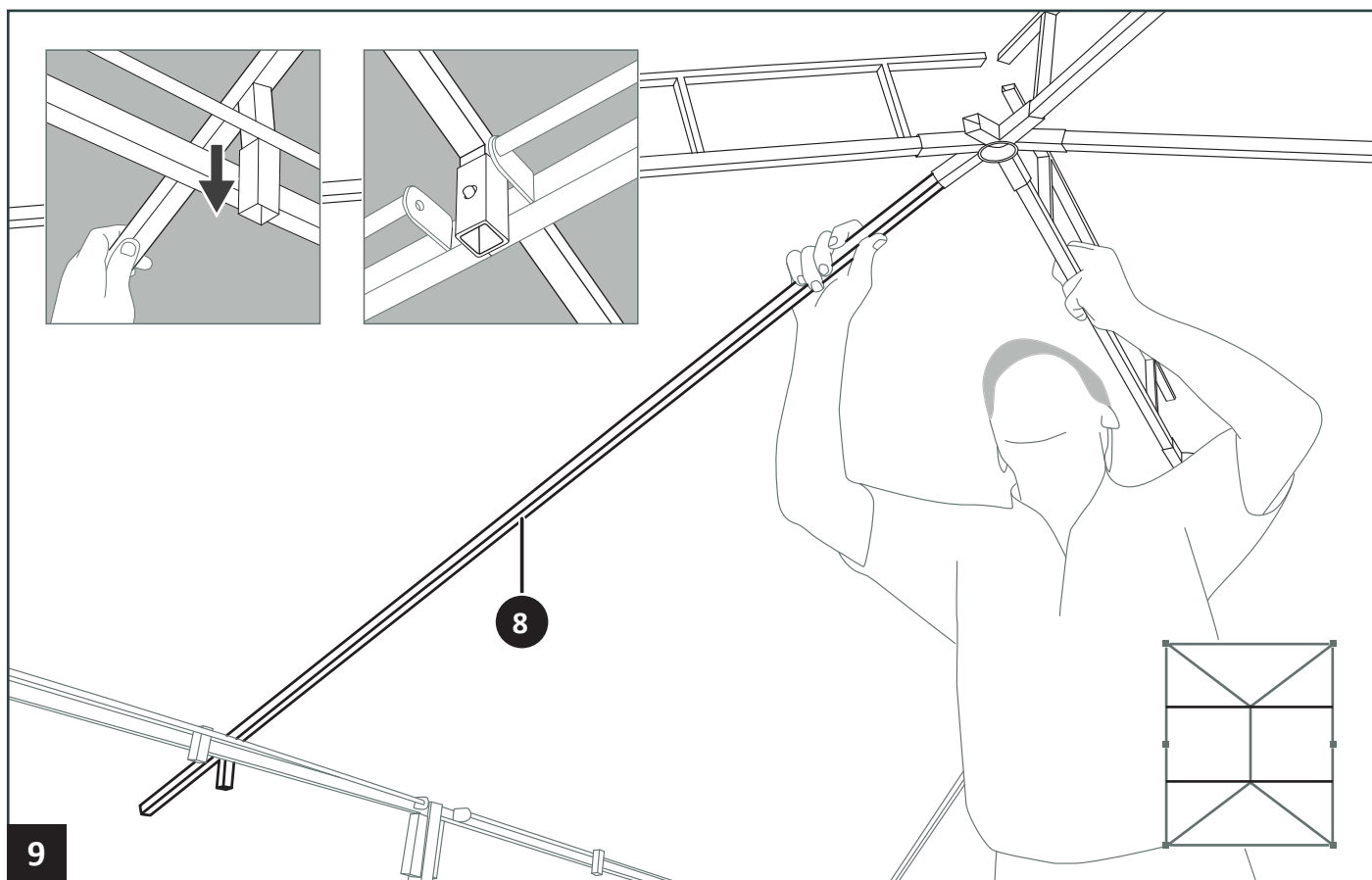

10

